

GaAs IC Reflective SPDT DC–6 GHz



AS209-321

Features

- Single Broadband Design Covers 802.11a, 802.11b and 3.5 GHz Fixed Wireless Applications
- Positive Voltage Control (0, +5 V)
- Low Insertion Loss Thru 6 GHz
- High Linearity
- QFN-12 3 x 3 mm Package
- Low Cost

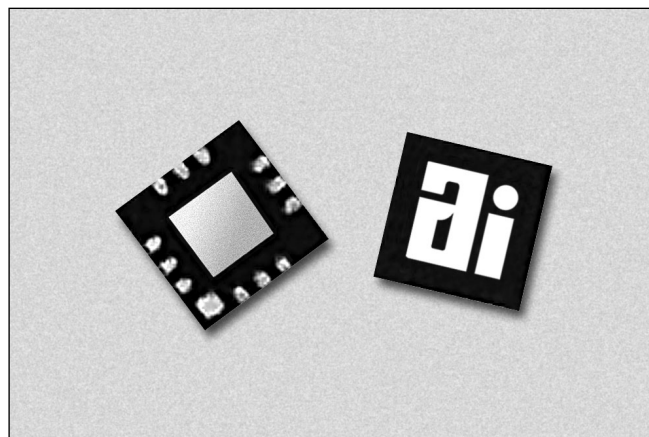

Description

The AS209-321 is a GaAs PHEMT reflective SPDT switch that has been designed for WLAN T_X/R_X applications. This device has been optimized to provide excellent performance from DC–6 GHz. The AS209-321's high frequency, low loss and high linearity make it an ideal choice for 802.11a, 802.11b and 3.5 GHz fixed wireless LAN applications.

Absolute Maximum Ratings

Characteristic	Value
RF Input Power	1 W Max. > 500 MHz
Control Voltage	-0.2 V, +6 V
Operating Temperature	-40°C to +85°C
Storage Temperature	-65°C to +150°C

Electrical Specifications at 25°C (0, +5 V)

Parameter	Frequency	Min.	Typ.	Max.	Unit
Insertion Loss	DC–2 GHz		0.7	1.0	dB
	DC–3 GHz		0.8	1.2	dB
	DC–4 GHz		1.1	1.4	dB
	DC–6 GHz		1.2	1.5	dB
Isolation	DC–2 GHz	30	34		dB
	DC–3 GHz	28	32		dB
	DC–4 GHz	25	29		dB
	DC–6 GHz	20	24		dB
Return Loss (On State)	DC–2 GHz	15	18		dB
	DC–3 GHz	12	15		dB
	DC–4 GHz	10	13		dB
	DC–6 GHz	10	13		dB

Operating Characteristics at 25°C (0, +5 V)

Parameter	Condition	Frequency	Min.	Typ.	Max.	Unit
Switching Characteristics	Rise, Fall (10/90% or 90/10% RF)			30		ns
	On, Off (50% CTL to 90/10% RF)			50		ns
	Video Feedthru			25		mV
Input Intermodulation Intercept Point (IIP3)	0/+5 V	1–4 GHz		46		dBm
Control Voltages	V _{C1} or V _{C2} = "0"		0		0.5	V
	V _{C1} or V _{C2} = "1" with @ 200 μA Max.		3.5		5.0	V

Typical Performance Data (0, +5 V, C_{BL} = 47 pF)

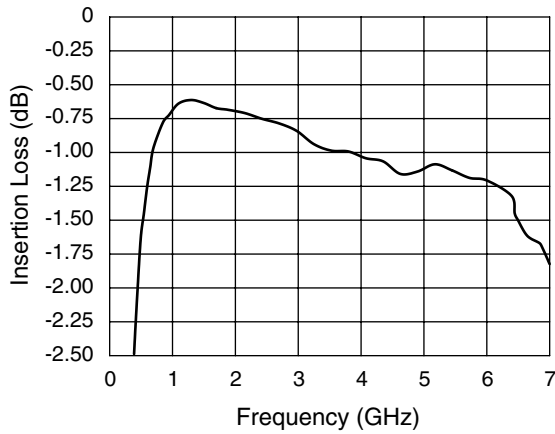

Insertion Loss vs. Frequency

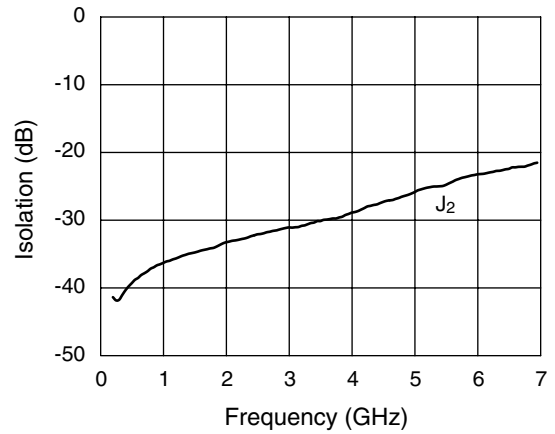

Isolation vs. Frequency

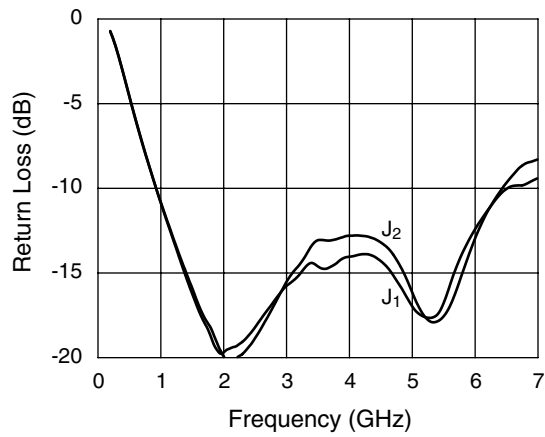

Return Loss vs. Frequency

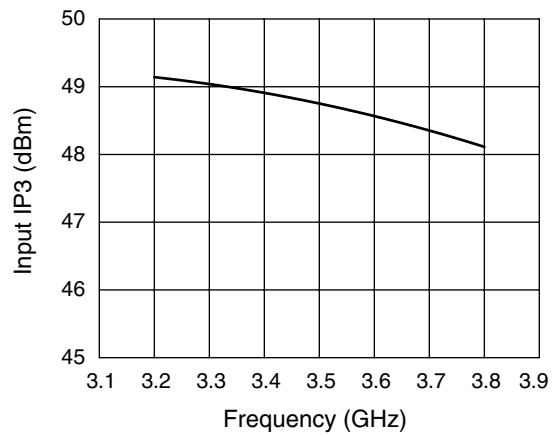

Input IP3 vs. Frequency

Truth Table

V _{C1}	V _{C2}	J ₁ -J ₂	J ₁ -J ₃
0	1	Insertion Loss	Isolation
1	0	Isolation	Insertion Loss

Pin Out

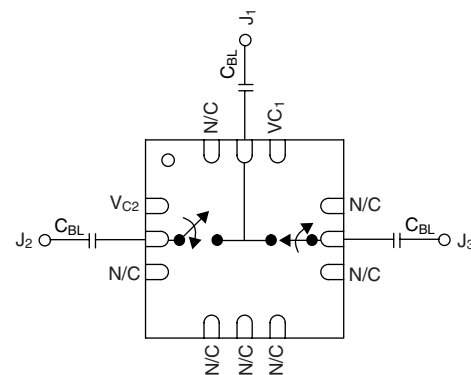

DC blocks required. C_{BL} = 47 pF for operation >500 MHz.

Evaluation Board Layout

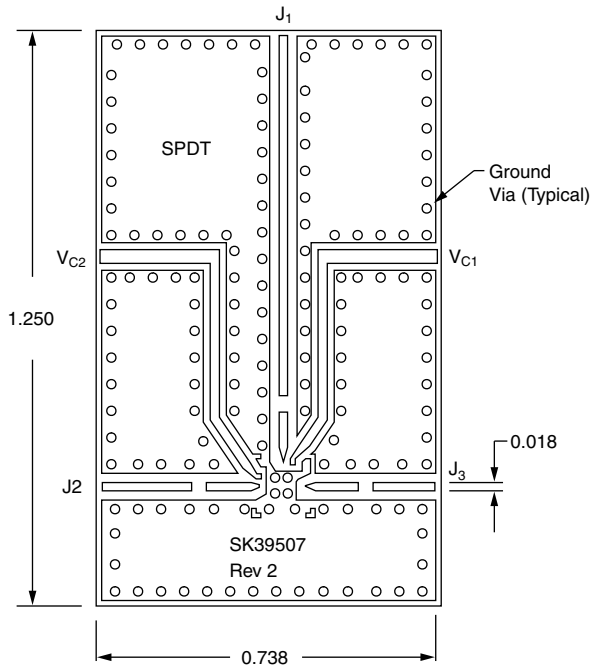

QFN-12

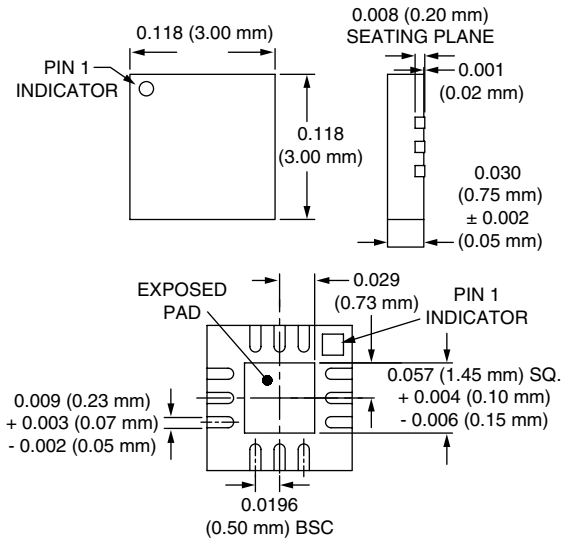

Board material: 10 mil FR4.

Typical S-Parameters (Control Voltage 0/+5 V)

Insertion Loss State # GHZ S DB R 50									Isolation State # GHZ S DB R 50							
Freq. (GHz)	S ₁₁	S _{11a}	S ₂₁	S _{21a}	S ₁₂	S _{12a}	S ₂₂	S _{22a}	S ₁₁	S _{11a}	S ₂₁	S _{21a}	S ₁₂	S _{12a}	S ₂₂	S _{22a}
0.50	-5.5	-90.1	-1.63	-2.6	-1.63	-1.9	-5.6	-122.6	-0.8	-98.7	-38.4	6.6	-39.5	10.0	-5.5	-122.4
0.95	-11.1	-136.0	-0.72	-51.1	-0.72	-50.0	-11.1	163.9	-1.6	-170.6	-36.3	-16.4	-35.8	-15.8	-11.0	162.9
1.50	-16.9	-177.2	-0.63	-98.3	-0.63	-98.6	-16.6	81.8	-2.2	120.6	-34.6	-45.2	-34.9	-46.3	-16.9	78.9
1.90	-19.7	165.5	-0.68	-130.2	-0.68	-130.6	-19.9	15.9	-2.3	78.5	-33.3	-67.2	-34.1	-68.1	-20.6	15.0
2.40	-18.3	128.3	-0.75	-170.0	-0.75	-168.5	-19.0	-67.9	-2.3	31.9	-32.1	-94.8	-31.4	-90.3	-19.8	-67.6
2.95	-15.7	68.2	-0.84	147.6	-0.84	148.2	-15.4	-141.6	-2.3	-14.9	-31.1	-127.6	-31.5	-126.0	-15.6	-140.3
3.55	-14.7	0.0	-0.99	104.4	-0.99	103.5	-13.1	147.3	-2.3	-63.1	-29.6	-160.3	-30.8	-159.6	-14.0	153.8
4.05	-13.9	-49.6	-1.04	67.4	-1.04	66.8	-12.8	96.4	-2.3	-101.6	-28.8	175.2	-29.3	172.7	-12.3	100.0
4.40	-14.2	-85.7	-1.07	41.4	-1.07	41.4	-13.1	57.7	-2.4	-128.0	-27.4	153.3	-28.0	155.5	-12.6	58.5
4.90	-16.9	-124.1	-1.14	4.1	-1.14	4.0	-15.9	-14.0	-2.4	-165.4	-25.9	122.8	-26.5	122.9	-15.7	-9.1
5.40	-17.2	-129.9	-1.13	-34.6	-1.13	-34.6	-17.7	-119.1	-2.5	158.1	-24.9	89.9	-25.8	89.6	-16.7	-111.6
6.00	-12.0	-165.9	-1.21	-82.2	-1.21	-81.2	-12.3	133.0	-2.6	114.2	-23.2	47.8	-23.9	47.4	-11.7	135.5
6.45	-10.0	153.5	-1.45	-116.4	-1.45	-115.5	-9.5	75.7	-2.7	80.8	-22.3	16.1	-23.7	23.1	-9.0	75.7
7.00	-9.5	103.6	-2.00	-156.8	-2.00	-158.9	-8.2	11.5	-2.8	39.3	-21.2	-23.8	-23.7	-23.4	-8.0	10.6

Measured S-parameters include the evaluation board.